

CLASSIC 110.135.xxx - double door

Reinforced glassfibre polyester parts, sandwich construction, insulated with polyurethane foam core
 Corner posts of GRP with vertical c-rails
 Textured surface in grey RAL 7032
 Protection class IP54
 Vertical c-rails provided at the side wall and rear wall

Door with 3-point locking device with burglary-resistant swing handle with profile cylinder to DIN 18252 (lockable)
 Basquil-locking-device for left door and overlapflange of stainless steel
 Roof overhang 25 mm all around

Arrangement

Floor (see data sheet [SD522](#) „Floor versions for classic series“)

Options

- MP** Mounting plate
- FA/FS** Acrylic glass/ Safety glass window
- C-VA** Vertical c-rails in stainless steel instead of aluminium
- GO** Antistatic to avoid electrostatic charges according to EN IEC 60079-0
- SB** Floor fastening (see data sheet [SD523](#) „Fastenings for classic-floor versions design ...“)
- WA** Wall fastening inside/ outside
- SZ** Ground vault

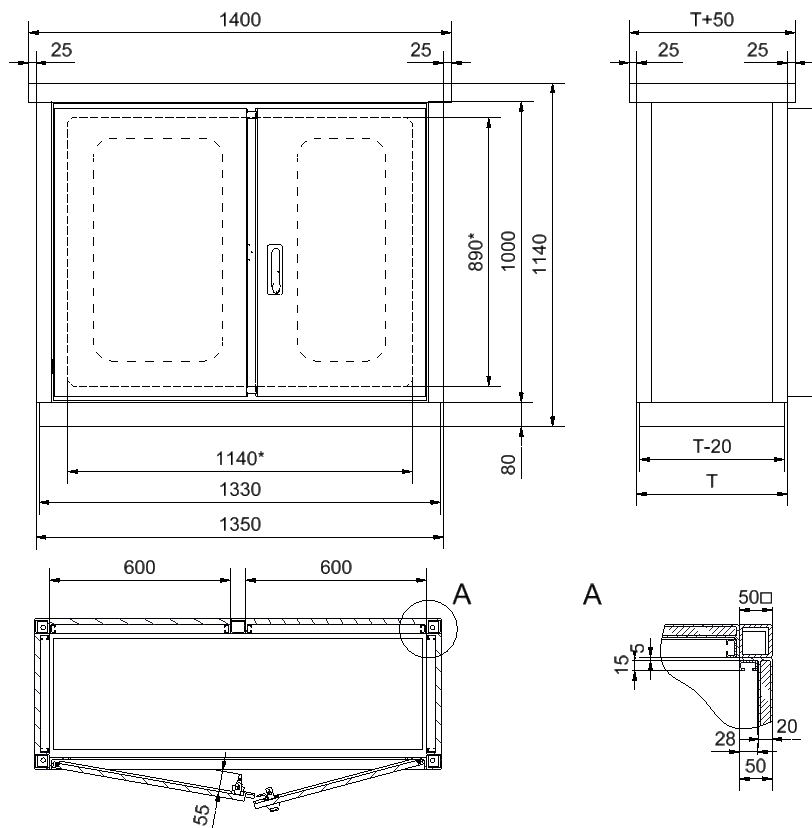

* clear width

Type	Sizes (mm) with floor		
	H	B	T
110.135.050	1140	1350	500
110.135.070			700
110.135.090			900
110.135.110			1100